

Splash down

Play system Splash down is a free standing play element in the shape of an airplane. The play system can be used as a standalone play element or combined with existing IKC products to create a fun play corner.

Can be combined with:
 • 1 play module of choice

Price is incl. the play module.



Graphic colours Pantone no.

285C	485C	540C	543C	CG 1C	White
------	------	------	------	-------	-------

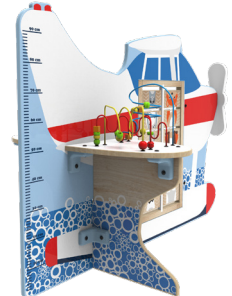

Play system | Splash down

Article no.	Size HxWxD	Mounting	Age	KG	Icons
PP00710	100x147,85x83,8cm	free standing	3 - 12 years	22,1 KG	MDF, PP, Schima superba, stainless steel



TÜV SGS All our products are inspected, tested and certified by SGS and TÜV.

EN 71 European standard EN 71 specifies safety requirements for toys. Compliance with the standard is legally required for all toys sold in the European Union.

FSC All our products only use FSC certified wood, so eco- and environment friendly!

CE Our products are conform with health, safety and environmental protection standards for products sold within the EU.

IKC | HQ EUROPE
 Dronten | The Netherlands
 +31 (0)321 38 77 30
 sales@ikcplay.com
 www.ikcplay.com

IKC | HQ ASIA
 Shanghai | China
 +86 (0)573 82 58 61 83
 sales.cn@ikcplay.com
 www.ikcplay.com.cn

Plane panels

PP1

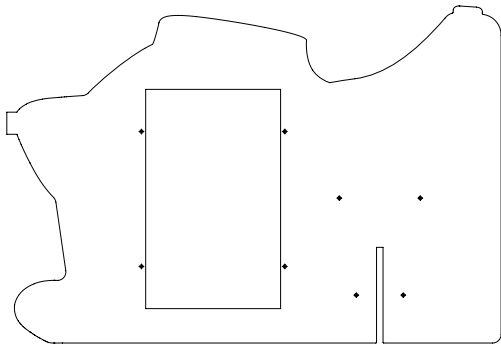

PP2

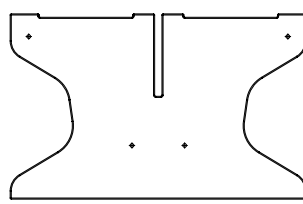

Required tools



Wing planes

WP1

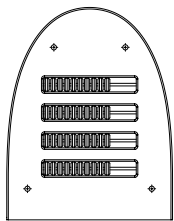

WP2

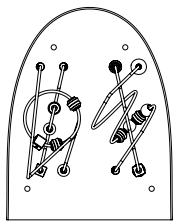

Corner piece

CP1

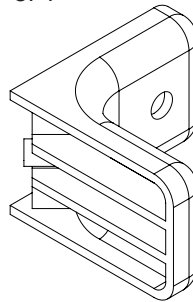

Propellor

PRP1

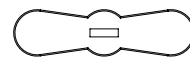

PRP2



Screws

S13

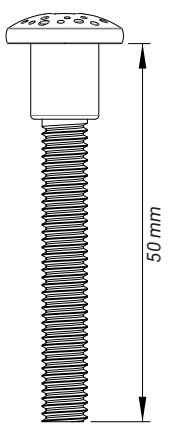

S5

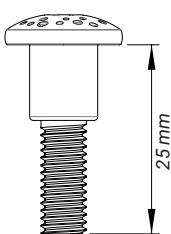

S14

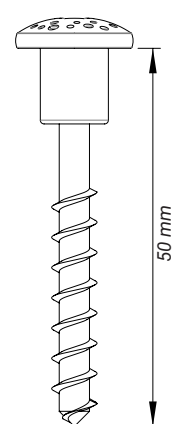

S19

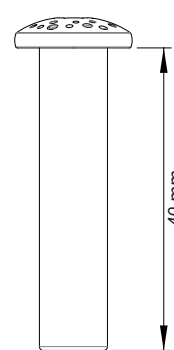

S18

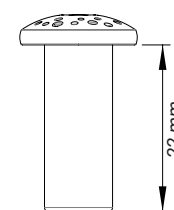

S17

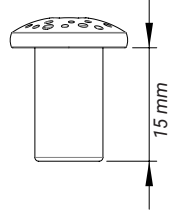

1.1 Install the plane panels

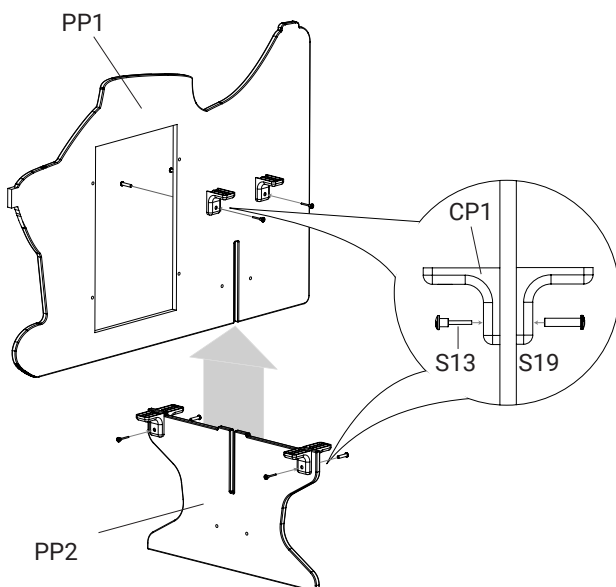
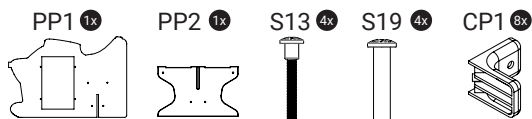

1.2 Install the corner pieces

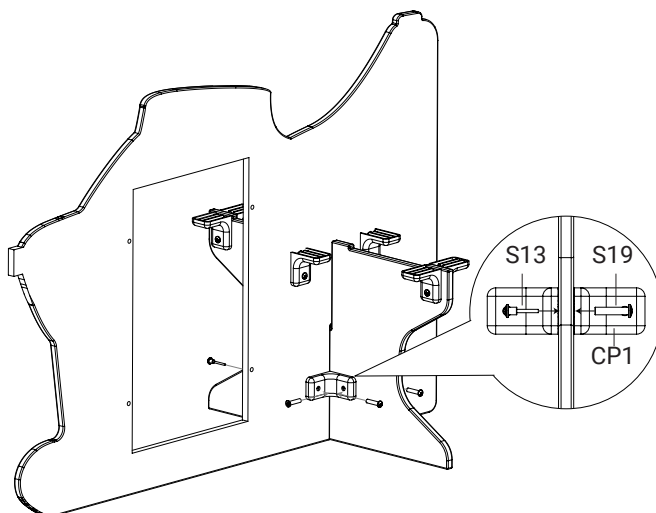
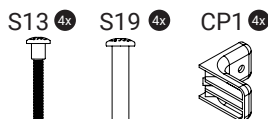

1.3 Install the wing planes

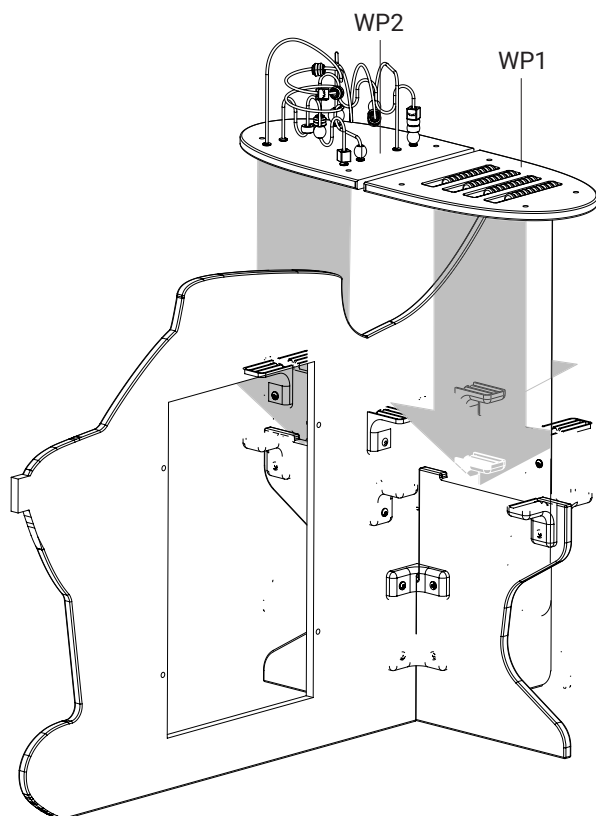

1.4 Mount the wing planes

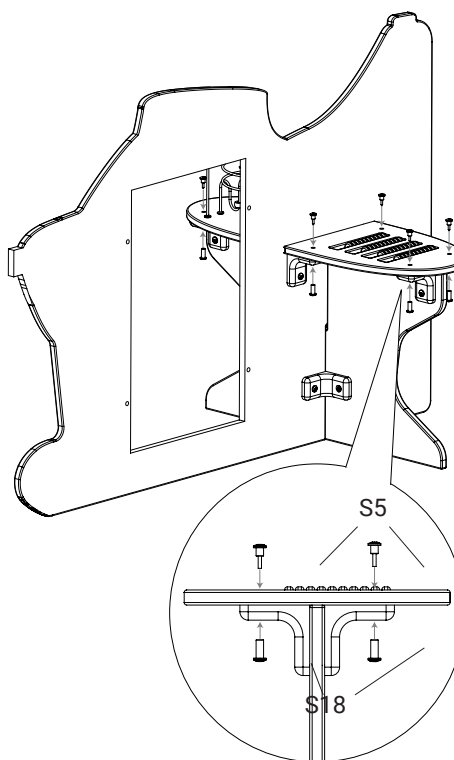
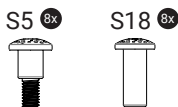

1.5 Install the propellor

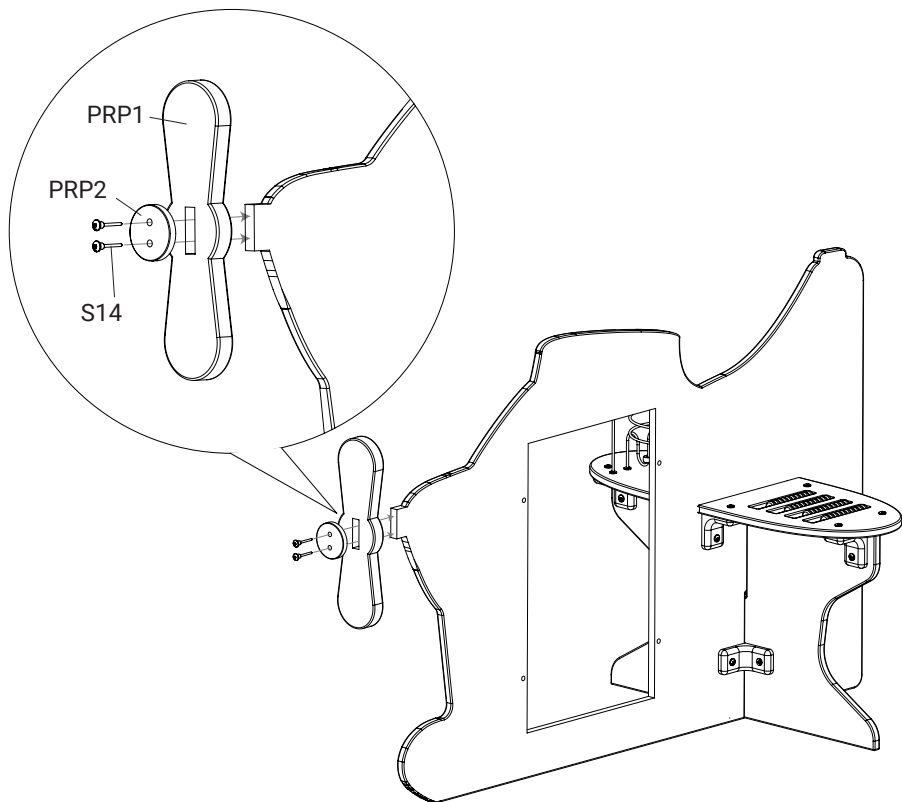
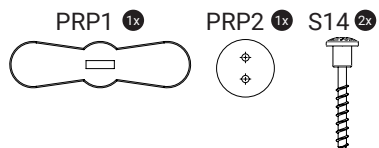

1.6 Install the side panels

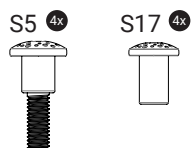

A playmodule is required

